

WRM-250

Wall Pan/Tilt arm

100 lbs (45 kg) max load

VESA 75x75 / 100x100 / 5"x2,75"

The WRM-250 is a heavy-duty speaker wall mount with pan and tilt functionality.

This bracket supports loudspeakers weighing up to 45 kg (100 lbs.) and comes with a design factor of 7:1. Its speaker & wall mount plate are installed separately and coupled very easily by just one person.

Tilt adjustments are simply achieved by means of a self-locking mechanism holding the speaker in place, even with all the bolts fully released.

The WRM-250 mount fits all loudspeakers that are foreseen from a universal mounting patterns (5" x 2,75", 4,25" x 2", 6,9" x 3,4", VESA 75x75 and 100x100). The WRM-250 is the way to go in all immersive sound applications given its pan ability of 0° to 90° rotation and -20° to +25° vertical tilt.



SPECIFICATIONS:

Functions	Pan and Tilt Speaker Wall Mount	
Mounting holes	4x dia 8,2 mm (dia 0.32") (5" x 2,75" pattern), x dia 8,2 mm (dia 0.32") (4,25" x 2" pattern), 4x dia 8,2 mm (dia 0.32") (6,9" x 3,4" pattern), VESA 75x75 / VESA 100x100	
Wall mounting plate	240x100 mm	9,45" x 3,94"
Pan angle	0° ... 90°	
Tilt angle	-20° ... +25°	
Load limit	45 kg	100 lbs
Design factor	7:1 ratio	
Dimensions	240 x 144 x 123 mm	9,45" x 5,69" x 4,84"
Shipping dimensions	490 x 140 x 280 mm	19,29" x 5,51" x 11,02"
Net weight	2,53 kg	5,58 lbs
Shipping weight (2 pcs per box)	5,36 kg	11,82 lbs

COMPABILITY:

Compatible MAG Cinema speakers:	SUR-63, SUR-83, SUR-103, SUR-123, SUR-153, SUR-153H, SUR-408, SUR-410, SUR-420.
Compatible JBL speakers:	8102, 9350, 9300, 9310, 9320, AC195, AC266, AC299, AC566, AC599, AC895
Compatible QSC speakers:	SR-800, SR-1000, SR-1020, SR-1030, SR-1290, SR-1590, SR-8101, SR-8200, SR-5152
Compatible Dolby speakers:	CS1090, CS1290S, CS1290C, 114RT-I-PXO, 8290V2; DSR-1090, DSR-1260, DSR-1280
Compatible Klipsch speakers:	KPT-250, KPT-1201, KPT-1200M, KPT-1260 H, KPT-8001
Compatible Vive Audio Christie speakers:	LS1S, LS2S, LS5S, LA3Si, LS2C, LA4S, LA3C, LA4C
Compatible Alcons speakers:	CCS8, CCS8S, CCS12, CRS12/9040, CRS12/9090, CRS12GT/60, CRS12GT/90
Compatible Meyer Sound speakers:	HMS-5, HMS-10, HMS-10 EASE, HMS-12, HMS-15, HMS-15AC, Ultra-X20/22/23, Ultra-X40/42
Compatible Krix speakers:	KX-1152, KX-1155, KX-1470, KX-1570, KX-1570F, KX-1840, KX-1870, KX-1870F, KX-1875

www.mnmounting.com
info@mnmounting.com
2 Merezhna str., Bila Tserkva,
Kyiv region, 09100, Ukraine

EMEA & Asian region:
+32 (0) 472 630212
USA, LATAM, Canada, Australia
& New Zealand region:
+1 (562) 607 7348



WRM-250

Wall Pan/Tilt arm

100 lbs (45 kg) max load

VESA 75x75 / 100x100 / 5"x2,75"

PACKAGE CONTENTS

1. WRM-250 wall mounting - 2 pcs
2. Hex key 6 - 1 pcs
3. Installation manual - 1 pcs

Dimensions

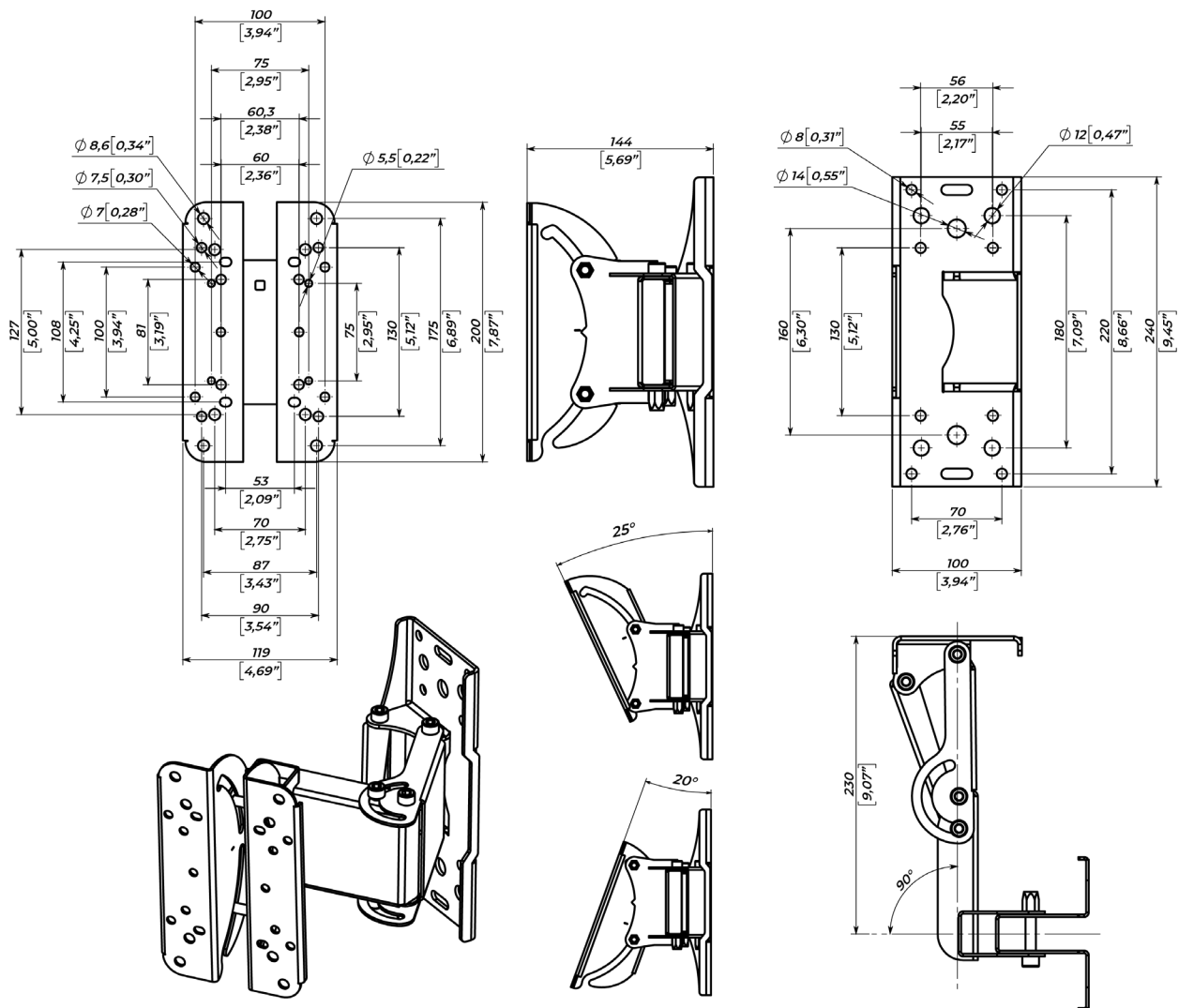

SAFETY INSTRUCTIONS

1. Entrust mounting equipment only to experienced professionals and strictly follow the provided safety instructions. Improperly installed equipment may result in property damage, personal injury and/or liability for the installing contractor.
2. **Always use safety cables!** This will prevent equipment from falling during setup or while exploitation.
3. Always carefully check the mounting surface of the wall. Make sure the wall or ceiling structure allows to hold the weight of the speaker including its bracket.
4. Only use appropriate fastening hardware.
5. Always make sure to securely use and lock all mounting bolts. Loose bolts may become unscrewed over time due to vibration which will then create a safety hazard.

www.mnmounting.com
info@mnmounting.com
2 Merezhna str., Bila Tserkva,
Kyiv region, 09100, Ukraine

EMEA & Asian region:
+32 (0) 472 630212
USA, LATAM, Canada, Australia
& New Zealand region:
+1 (562) 607 7348

